

INSTALLATION INSTRUCTIONS

BULL BAR 08-ON FORD ESCAPE / 08-ON MAZDA TRIBUTE VGUBG-1873-0884BK

PARTS LIST:

1	Bull Bar	4	10mm Nylock Nuts
1	Driver/Left Mounting Bracket	4	10mm ID x 30mm OD x 2.5mm Flat Washers
1	Passenger/Right Mounting Bracket	2	12-1.75mm x 50mm Hex Head Bolts
1	Driver/Left Bull Bar Bracket	4	12-1.75mm x 30mm Hex Head Bolts
1	Passenger/Right Bull Bar Bracket	4	12mm Nylock Nuts
2	Top Support Brackets	2	12mm Lock Washers
1	10-1.50mm Driver Side U-Bolt	10	12mm ID x 37mm OD x 3mm Flat Washers
1	10-1.50mm Passenger Side U-Bolt	2	8mm Nylock Nut
2	8-1.25mm x 20mm Bolt Plate (58mm x 18mm plate)	2	8mm ID x 24mm OD x 2mm Flat Washers

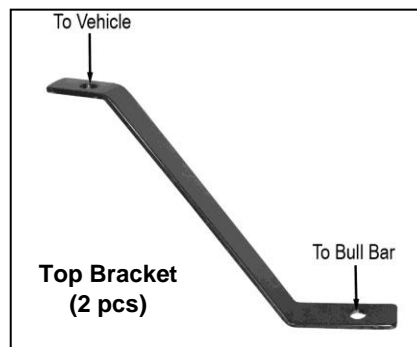
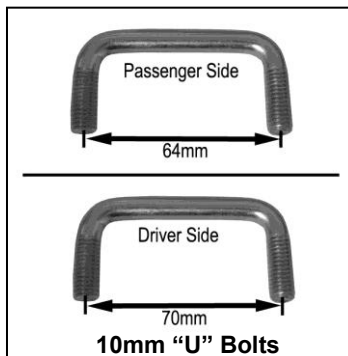

PROCEDURE:

1. REMOVE CONTENTS FROM BOX. VERIFY ALL PARTS ARE PRESENT. READ INSTRUCTIONS CAREFULLY BEFORE STARTING INSTALLATION. DO NOT ATTEMPT INSTALLATION ALONE; PERSONAL INJURY OR DAMAGE TO THE TRUCK MAY RESULT.
2. From underside of vehicle, remove the passenger and driver side splash shield and the air valance.
3. Measure and mark 12 1/2" from the outside and towards the inside of each end of the air valance. **NOTE:** Do not follow the contour of the air valance when measuring. Use a hacksaw to cut out 1" gap on each marked location on the air dam shown in **Figure 1 & 2**. **NOTE:** The air valance will be in three pieces, when re-installing.
4. Trim the splash shields as shown in **Figure 3 & 4**.
5. Re-Install the splash shields back onto the vehicle, note that one mounting location is missing from each splash shield. These will be secured beneath the included Mounting Brackets when installed (**Figure 5**).
6. Re-install the air valance back to the vehicle. **NOTE:** The air valance will mount back to the vehicle using the center factory bolt and the clips (**Figure 5**).
7. Starting on the driver side of the vehicle, locate the two non-threaded factory holes in the bottom of the cross member and insert driver side "U" Bolt (larger) through factory hole as shown in **Figure 5**.
8. Position driver side Mounting Bracket over already inserted "U"-Bolt and installed splash shield. **NOTE:** Once the Mounting bracket is fully tightened, it will hold the splash shield in place. Trim and fit the splash shield and air valance if needed as you installed the Mounting Bracket. You might need to slightly pull on the air valance towards the front of the vehicle in order to slide the Mounting Bracket between the splash shield and air valance (**Figure 6**).
9. Secure the Mounting Bracket to "U" Bolt using (2) 10mm Nylock Nuts and (2) 10mm Flat Washers (**Figure 6**). Do not tighten at this time.
10. Repeat steps 7 - 9 for passenger side Mounting Bracket.
11. On each of the outer bumper intake there is one plastic fastener on the upper section. Use a flat screw driver to remove these plastic fasteners (**Figure 7**).
12. Engage (1 ea) 8mm x 25mm Bolt Plate through the top of each factory hole where you previously removed the plastic fasteners (**Figure 8**).
13. Partially hang Top Brackets to already installed Bolt Plates by using (2) 8mm Nylock Nuts and (2) 8mm Flat Washers (**Figure 9**). Do not tighten at this time.
14. Remove the two outer skid plate upper bolts on the Bull Bar (**Figure 10**). **NOTE:** This will be the Top Bracket mounting location.
15. Determine passenger and driver Bull Bar Mounting Brackets and hand tighten them to Bull Bar using (2) 12-1.75mm Hex Head Bolts, (2) 12mm Lock Washers, and (2) 12mm Flat Washers (**Figure 11**).
16. With help position Bull Bar on the outer side of Mounting Brackets. Attach Bull Bar to Mounting Brackets using (4) 12mm x 30mm Hex Head Bolts, (4) 12mm Nylock Nuts, and (8) 12mm Flat Washers (**Figure 12**). Do not tighten at this time.
17. Attach Top Bracket to Bull Bar using the bolts removed in step 11 (**Figure 13**).
18. Level and adjust Bull Bar; and then tighten all hardware at this time.
19. Do periodic inspections to the installation to make sure that all hardware is secure and tight.

To protect your investment, wax this product after installing. Regular waxing is recommended to add a protective layer over the finish. Do not use any type of polish or wax that may contain abrasives that could damage the finish.

For stainless steel: Aluminum polish may be used to polish small scratches and scuffs on the finish. Mild soap may be used also to clean the Bull Bar.

For gloss black finishes: Mild soap may be used to clean the Bull Bar.

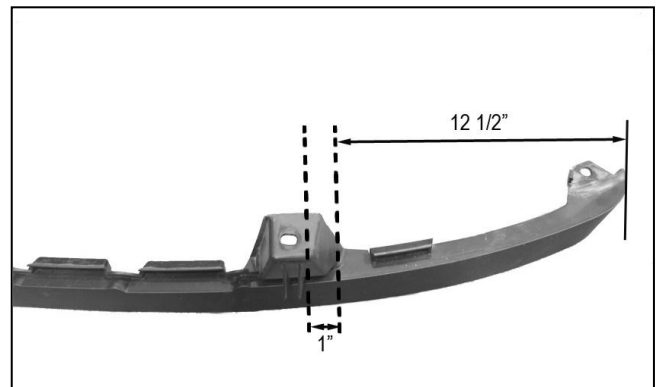
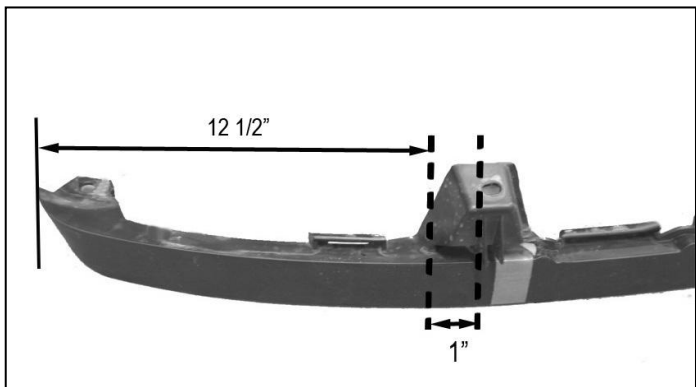

Fig 1

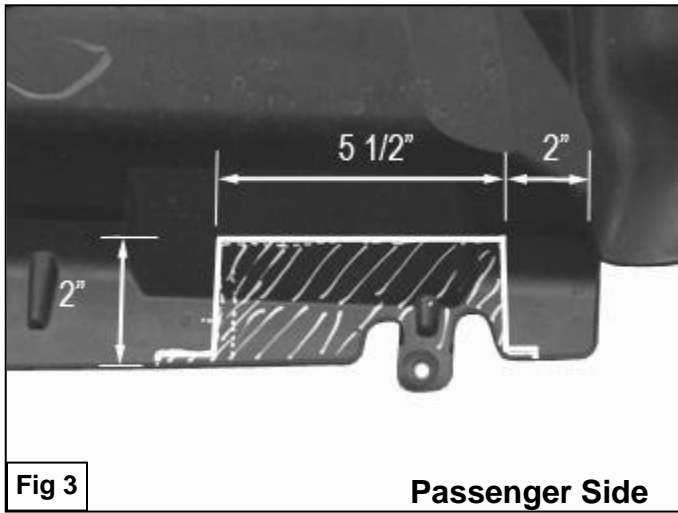

Fig 3

Passenger Side

Fig 2

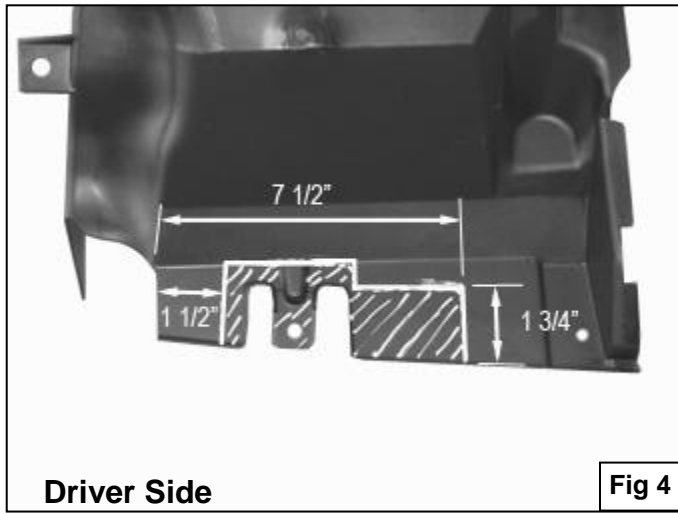

Fig 4

Driver Side

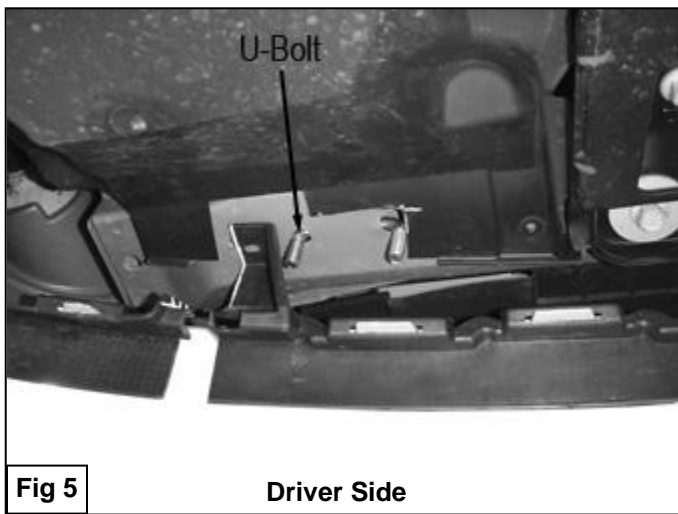

Fig 5

Driver Side

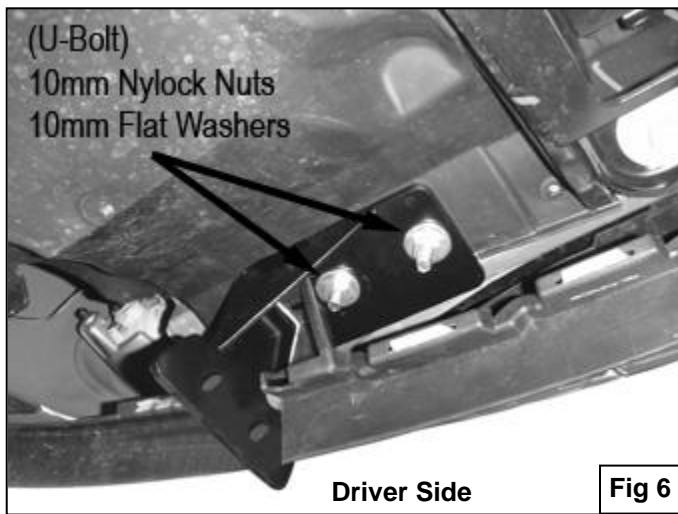

Fig 6

(U-Bolt)
10mm Nylock Nuts
10mm Flat Washers

Driver Side

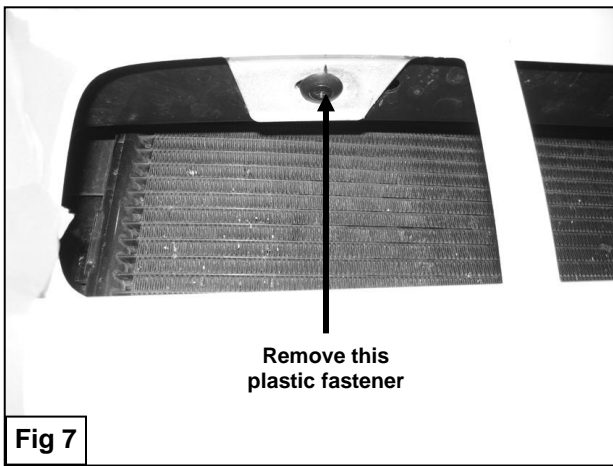

Fig 7

Remove this
plastic fastener

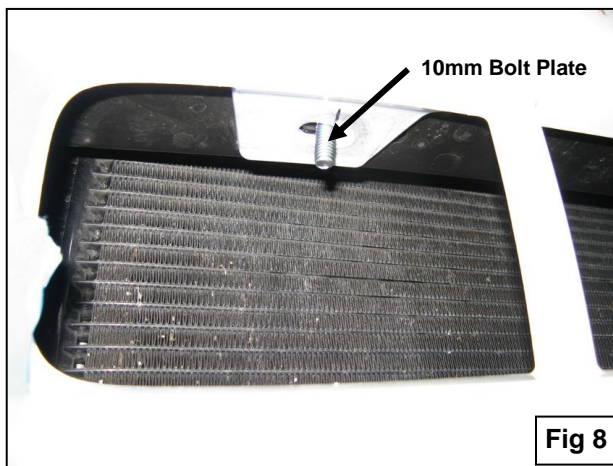

Fig 8

10mm Bolt Plate

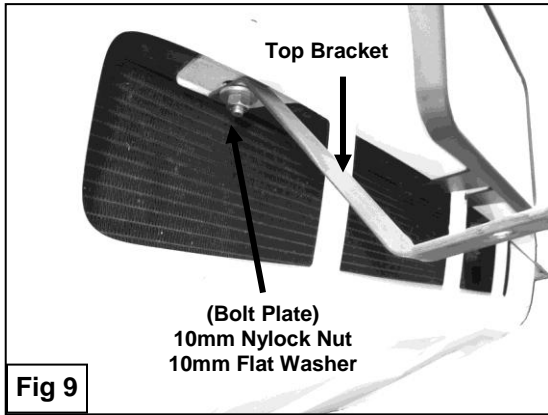

Fig 9

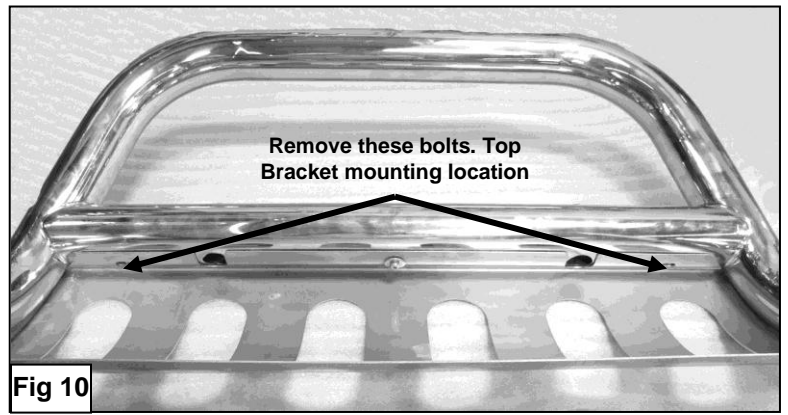

Fig 10

**Mounting Bracket Shown Installed Without
Splash Shield or Air Valance**

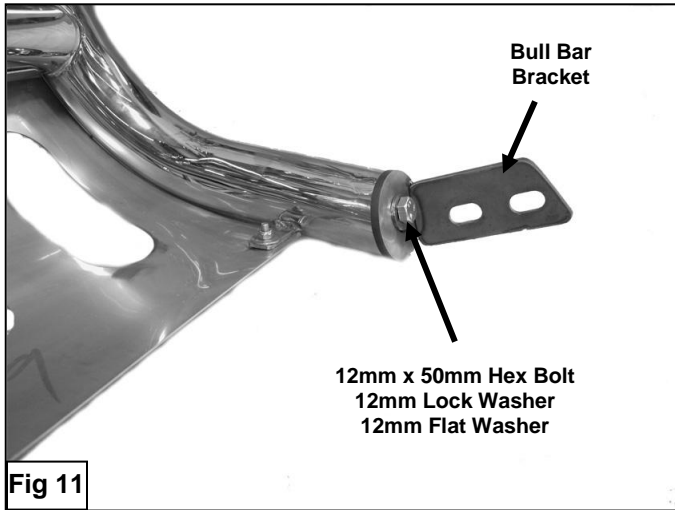

Fig 11

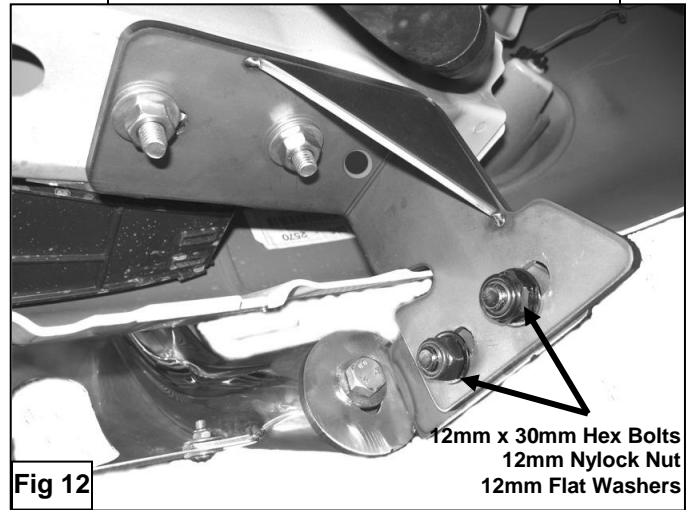

Fig 12

Installation Complete

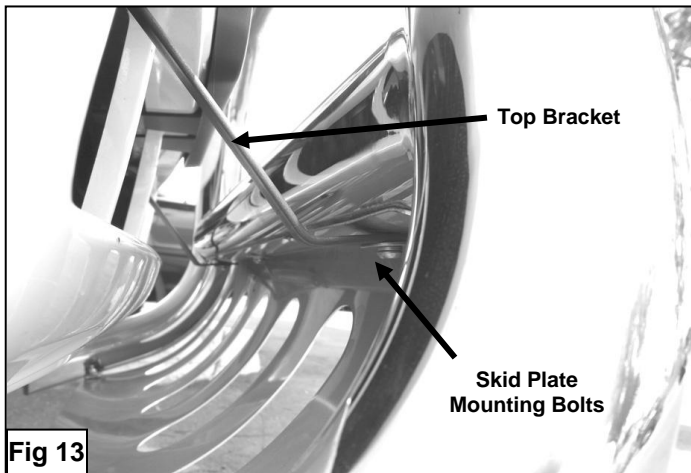

Fig 13



Fig 14