

PARTS LIST:

1	Driver/Left Sidebar	2	8mm Threaded Inserts
1	Passenger/Right Sidebar	1	Insert Tool
1	Driver/Left Front Mounting Bracket	4	12-1.75mm x 32mm OD x 3mm Flat Washers
1	Passenger/Right Front Mounting Bracket	4	12mm Lock Washers
1	Driver/Left Rear Mounting Bracket	4	12mm Hex Nuts
1	Passenger/Right Rear Mounting Bracket	6	10-1.50mm x 30mm Hex Bolts
1	Driver/Left Front Support Bracket	4	10mm x 27mm OD x 3mm Large Flat Washers
1	Passenger/Right Front Support Bracket	12	10mm x 20mm OD x 2mm Small Flat Washers
1	Driver/Left Rear Support Bracket	4	10mm Lock Washers
1	Passenger/Right Rear Support Bracket	6	10mm Nylon Lock Nuts
2	12-1.75mm x 35mm T-Bolt Plate (Front Bracket Only)	4	10mm Hex Nuts
2	10-1.50mm x 35mm "Wide" T-Bolt Plate (Front Support Bracket Only)	10	8-1.25mm x 30mm Hex Bolts
2	12-1.75mm x 40mm Long Bolt Plate (Rear Bracket Only)	10	8mm x 24mm OD x 2mm Flat washers
2	10-1.50mm x 35mm Bolt Plate (Rear Bracket Only)	10	8mm Lock Washers

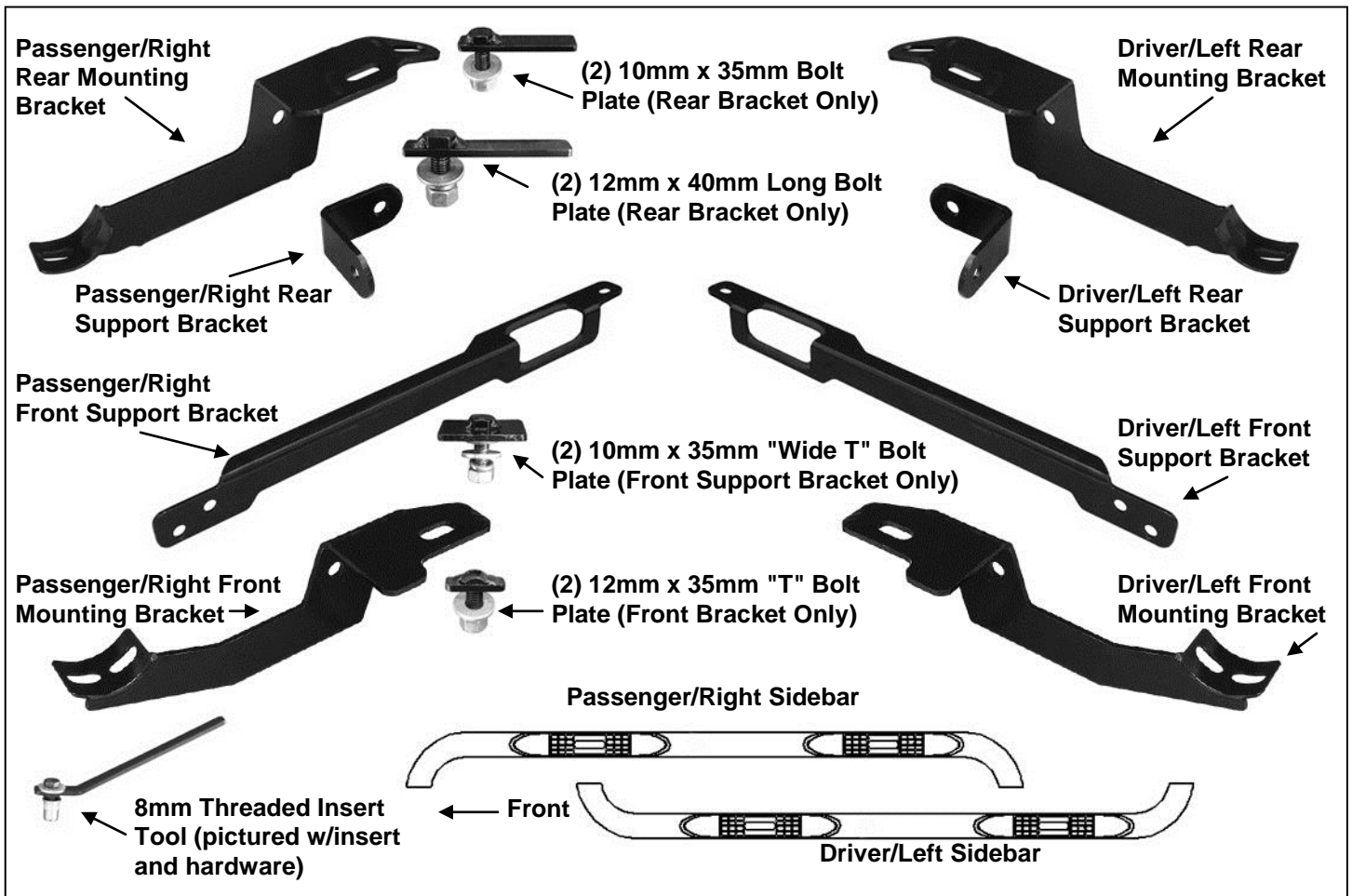

PROCEDURE:

- 1. REMOVE CONTENTS FROM BOX. VERIFY ALL PARTS ARE PRESENT. READ INSTRUCTIONS CAREFULLY BEFORE STARTING INSTALLATION. DRILLING IS REQUIRED. ASSISTANCE IS RECOMMENDED.**
2. Start installation under the driver side of the vehicle. Select (1) 12mm x 35mm Small T-Bolt Plate and insert it into the factory oval hole in the floor panel, **(Figures 1A & 1B)**. Rotate the Bolt Plate 90-degrees so that the plate is across the oval hole. Select the driver side front Mounting Bracket. Hang the Bracket from the Bolt Plate with (1) 12mm Flat Washer, (1) 12mm Lock Washer and (1) 12mm Hex Nut, **(Figure 2)**. **NOTE:** Make sure that the mounting flange on the Front Bracket is lined up properly with the indent in the floor panel. The Front Mounting Bracket must sit flat against the floor panel. Do not tighten hardware at this time.
3. Insert (1) 10mm x 35mm Wide T-Bolt Plate, **(Figure 3B)**, into the large round hole in the bottom of the inner frame channel, **(Figure 3A)**. Rotate the Bolt Plate so that the plate is inline with the Support Bracket and 90-degrees to the direction of the frame channel. Select the driver side Front Support Bracket. Hang the Support Bracket from the Bolt Plate and secure it with the included (1) 10mm x 27mm Large Flat Washer, (1) 10mm Lock Washer and (1) 10mm Hex Nut, **(Figure 4)**. Do not tighten hardware at this time.
4. Hold the Support Bracket up to the back of the Front Bracket and line up the (2) mounting holes. Bolt the two Brackets together with the included (2) 10mm x 30mm Hex Bolts, (4) 10mm x 20mm Small Flat Washers and (2) 10mm Nylon Lock Nuts, **(Figure 5)**. Snug but do not tighten hardware at this time.
5. Select the driver side rear Mounting Bracket and (1) "L" Rear Support Bracket. Bolt the Support Bracket to the front facing side of the Mounting Bracket with (1) 10mm x 30mm Hex Bolt, (2) 10mm x 20mm Small Flat Washers and (1) 10mm Nylon Lock Nut, **(Figures 7A & 7B)**.
6. Locate the oval and round holes in the floor panel toward the rear of the vehicle, **(Figure 6A)**. Insert (1) 10mm x 35mm Bolt Plate into the round hole, **(Figure 6B)**. Insert (1) 12mm x 40mm Long Bolt Plate into the oval hole next to the pinch weld, **(Figure 6C)**. Rotate the Bolt Plate 90-degrees so that the plate is across the oval hole. Position the Rear Mounting Bracket over the (2) Bolt Plates. Secure the Bracket to the 12mm Bolt Plate with (1) 12mm Flat Washer, (1) 12mm Lock Washer and (1) 12mm Hex Nut, **(Figure 7)**. Bolt the Bracket to the 10mm Bolt Plate with the included (1) 10mm x 27mm OD Large Flat Washer, (1) 10mm Lock Washer and (1) 10mm Hex Nut. Hold the Support Bracket firmly against the back of the pinch weld and tighten the hardware at this time.
7. Select the driver Sidebar and carefully place it onto the Mounting Brackets to avoid damaging the finish on the Sidebar. Line up the holes in the Sidebar with the Mounting Brackets and bolt together with the included (4) 8mm x 30mm Hex Bolts, (4) 8mm Flat Washers and (4) 8mm Lock Washers, **(Figure 8)**.
8. Level and adjust the Sidebar and tighten all hardware except the 10mm hex bolt securing the "L" Rear Support Bracket to the Rear Mounting Bracket, **(Figure 9)**.
9. Move back to the driver side Rear Mounting Bracket. Hold the "L" Support Bracket firmly against the back of the pinch weld. Mark the mounting hole location on the "L" Support Bracket onto the pinch weld, **(Figure 9)**. Check the Sidebar for level before proceeding. **CAUTION:** Do not drill the hole too close to the bottom edge of the pinch weld.
10. Remove the "L" Support Bracket. Carefully drill this location with a 7/16" drill bit, **(Figure 10A)**. **IMPORTANT!** Be very careful and drill slowly through the pinch weld to avoid damaging the outer rocker panel cover. Any cutting or drilling tool may break or shatter. Government regulations require safety glasses & equipment at all times when cutting or drilling.
11. Assemble the Threaded Insert installation tool as pictured in **Figure 10B**. Hold the handle and push the insert into the drilled hole in the pinch weld. **NOTE:** Insert must fit snug in hole. If necessary, use a small hammer to carefully tap the insert into the hole until the rim on the insert is flush against the pinch weld. Firmly hold the tool handle and tighten the hex bolt in the tool to expand the insert in the hole. Continue until threads are flush with the top of the insert, **(Figure 10C)**. Remove the tool and hardware. Bolt the Support Bracket to the threaded insert with (1) 8mm x 30mm Hex Bolt, (1) 8mm Flat Washer and (1) 8mm Lock Washer, **(Figure 11)**. Tighten hardware at this time.
12. Repeat Steps 2-11 for passenger/right Sidebar installation.
13. Do periodic inspections to the installation to make sure that all hardware is secure and tight.

To protect your investment, wax this product after installing. Regular waxing is recommended to add a protective layer over the finish. Do not use any type of polish or wax that may contain abrasives that could damage the finish.

For stainless steel: Aluminum polish may be used to polish small scratches and scuffs on the finish. Mild soap may be used also to clean the Sidebar.

For gloss black finishes: Mild soap may be used to clean the Sidebar.

Driver/Left Side Installation Pictured

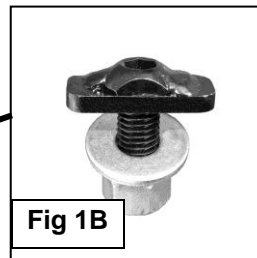
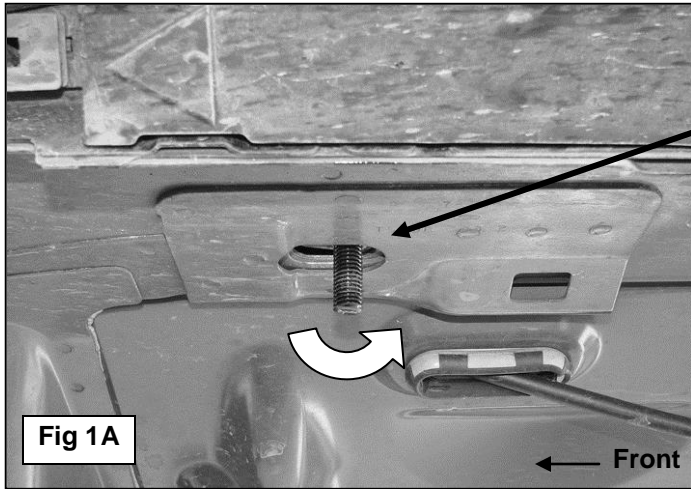

12mm x 35mm T-Bolt Plate
12mm Flat Washer
12mm Lock Washer
12mm Hex Nut

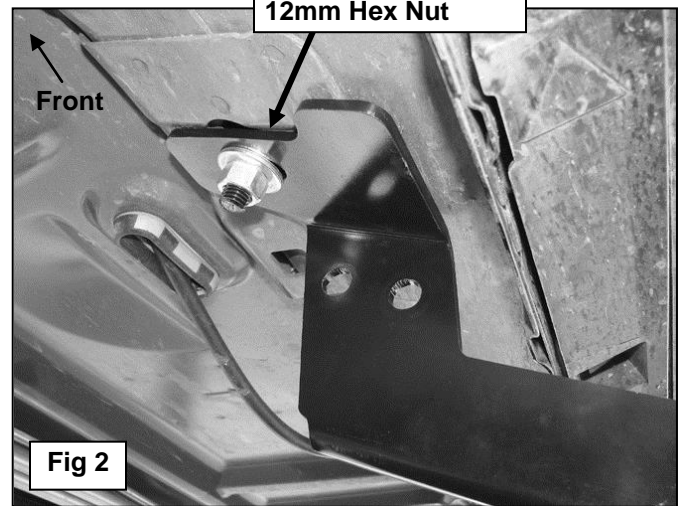

12mm Flat Washer
12mm Lock Washer
12mm Hex Nut

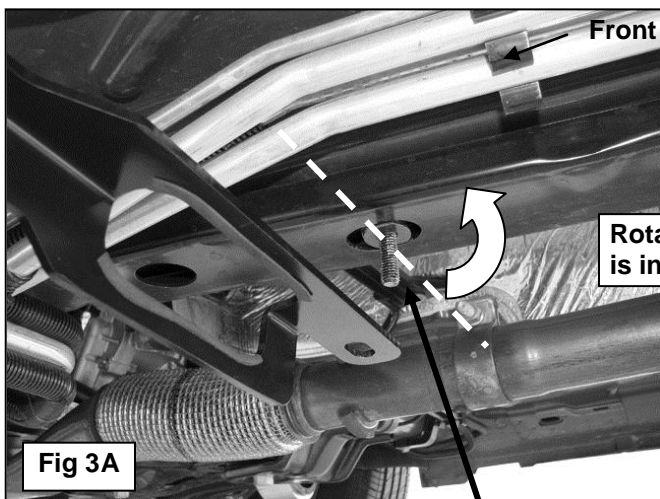

Rotate Bolt Plate so that plate is in line with Support Bracket

10mm Wide T-Bolt Plate
10mm x 27mm Large Flat Washer
10mm Lock Washer
10mm Hex Nut

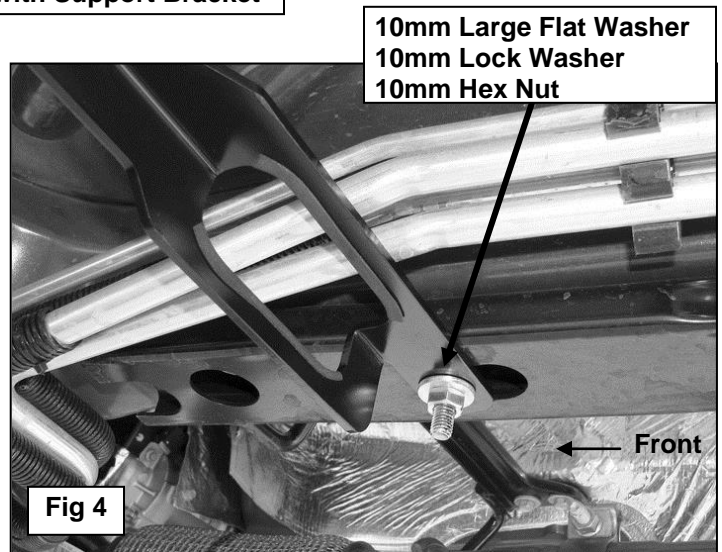
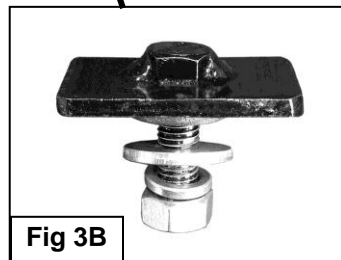

10mm Large Flat Washer
10mm Lock Washer
10mm Hex Nut

Driver Side Installation Pictured

- (2) 10mm x 25 Hex Bolts
- (4) 10mm x 20mm Small Flat Washers
- (2) 10mm Nylon Lock Nuts

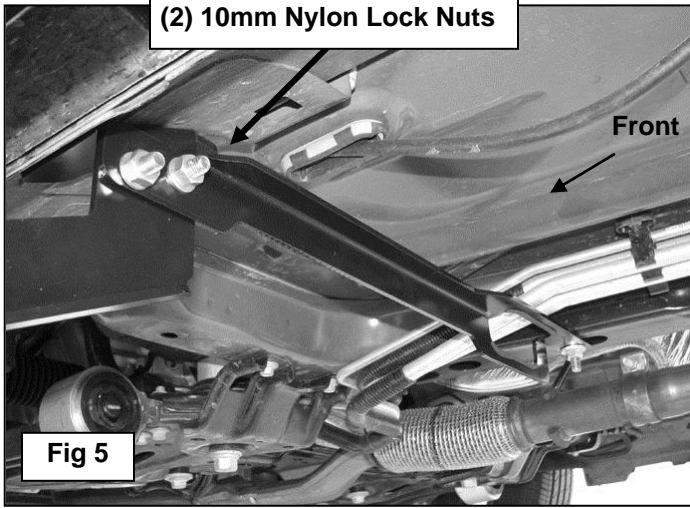

Fig 5

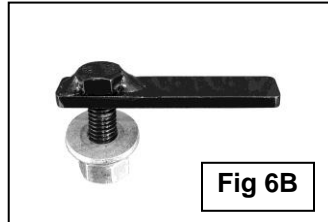

Fig 6B

- 10mm x 35mm Bolt Plate
- 10mm Large Flat Washer
- 10mm Lock Washer
- 10mm Hex Nut

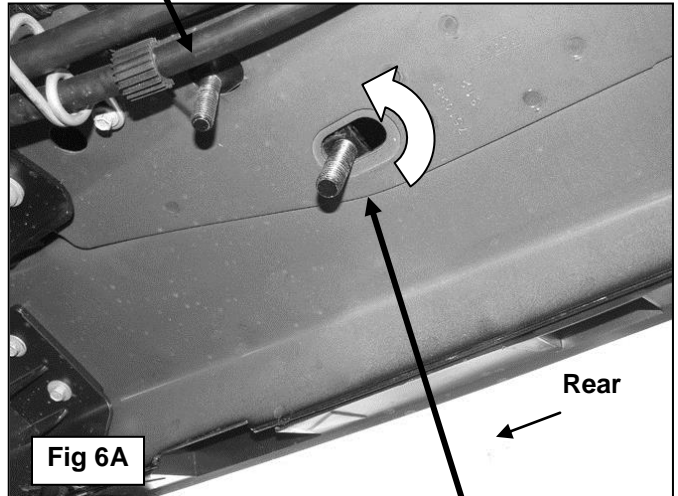

Fig 6A

Hold the Support Bracket firmly against the back of the pinch weld and tighten the hardware on the Mounting Bracket

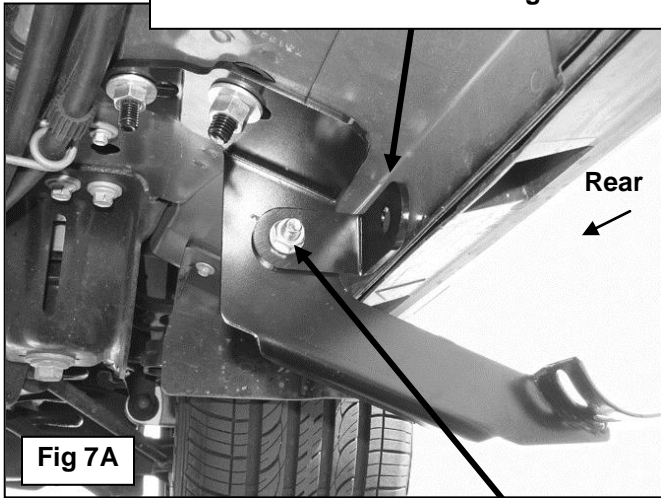

Fig 7A

- 12mm x 40mm Long Bolt Plate
- 12mm Flat Washer
- 12mm Lock Washer
- 12mm Hex Nut

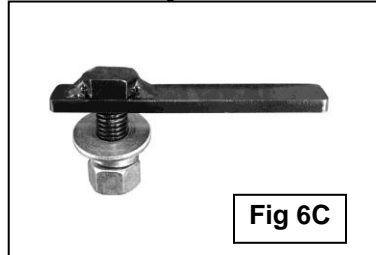

Fig 6C

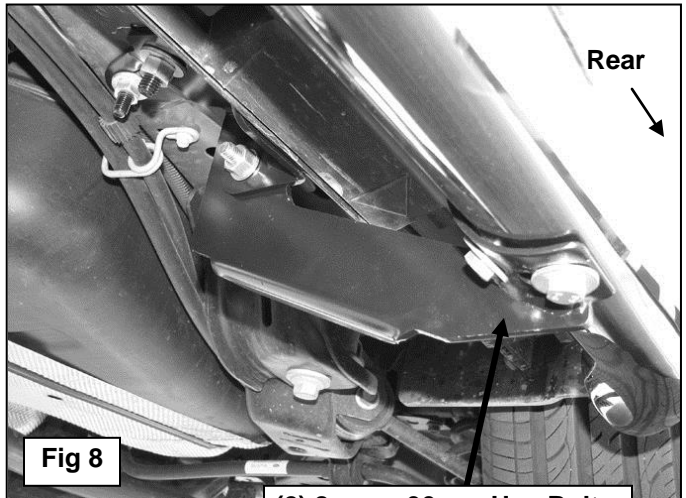

Fig 8

- (2) 8mm x 30mm Hex Bolts
- (2) 8mm Flat Washers
- (2) 8mm Lock Washers

- 10mm x 30 Hex Bolt
- (2) 10mm Flat Washers
- 10mm Nylon Lock Nut

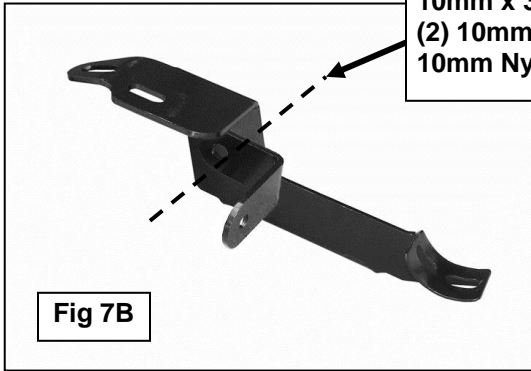
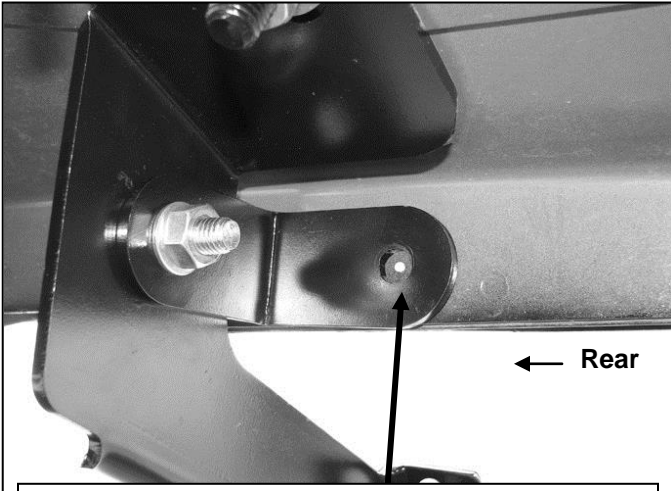
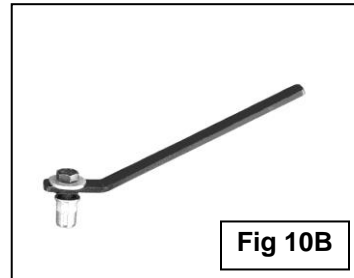

Fig 7B

Driver Side Installation Pictured



(Fig 9) Mark Support Bracket location onto pinch weld. Carefully drill the location with 7/16" drill bit. Do not drill and install the Insert until after the Sidebar has been completely installed, checked for level and aligned on the vehicle



**8mm x 30mm Hex Bolt
8mm Flat Washer
Insert Tool
8mm Expanding
Threaded Insert**

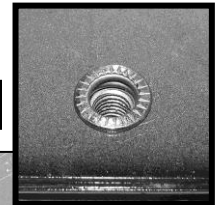

Fig 10C

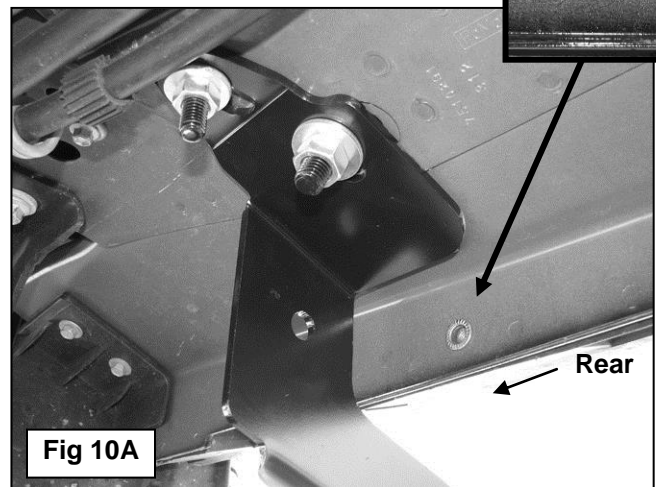

Fig 10A

Use the assembled tool (Fig 10B) to hold the Insert fully in place. Tighten hex bolt in Insert until threads are pulled up to the top (rim) of the insert

**10mm x 30 Hex Bolt
(2) 10mm Flat Washers
10mm Nylon Lock Nut**

**8mm x 30mm Hex Bolt
8mm Flat Washer
8mm Lock Washer**

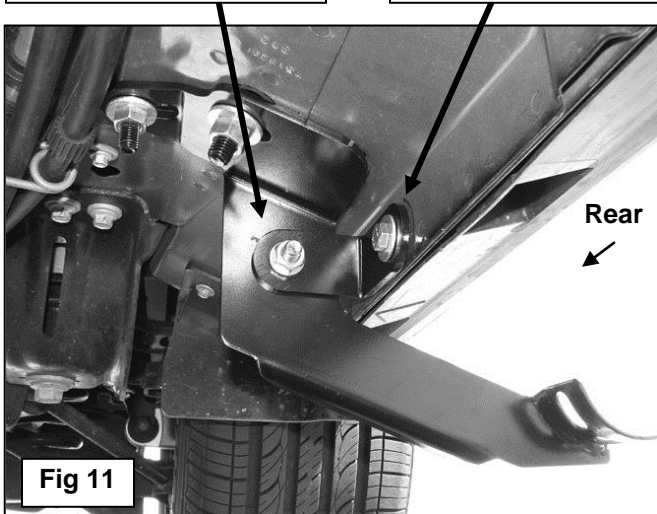
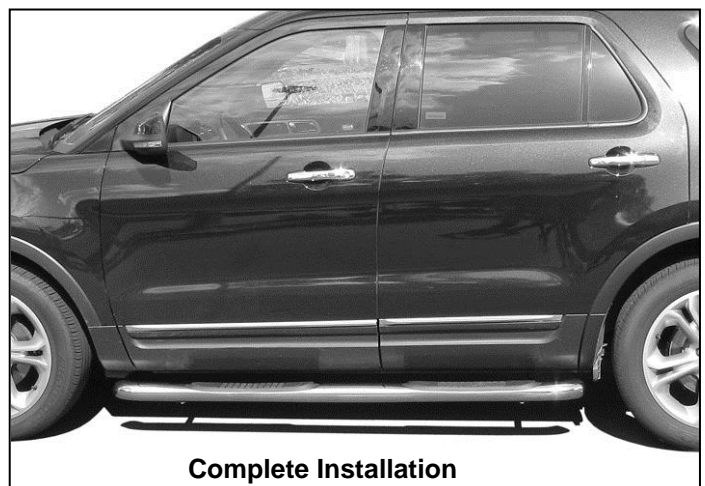

Fig 11



Complete Installation